



ASSEMBLY INSTRUCTIONS

**DENVER
ARMCHAIR**

TRAVEL GLIDE REMOVAL INSTRUCTIONS

FURNITURE IS HEAVY, MOVING OR LIFTING SHOULD NOT BE ATTEMPTED ON YOUR OWN

PLEASE NOTE: THIS PRODUCT IS FITTED WITH TRAVEL GLIDES FOR TRANSPORT PURPOSES ONLY. TRAVEL GLIDES MUST BE REMOVED AS FOLLOWS:

1. TILT UNIT ON ITS BACK
2. UNSCREW LARGE 70mm BLACK TRAVEL GLIDE
3. DO NOT REMOVE SMALL REAR BACK GLIDE

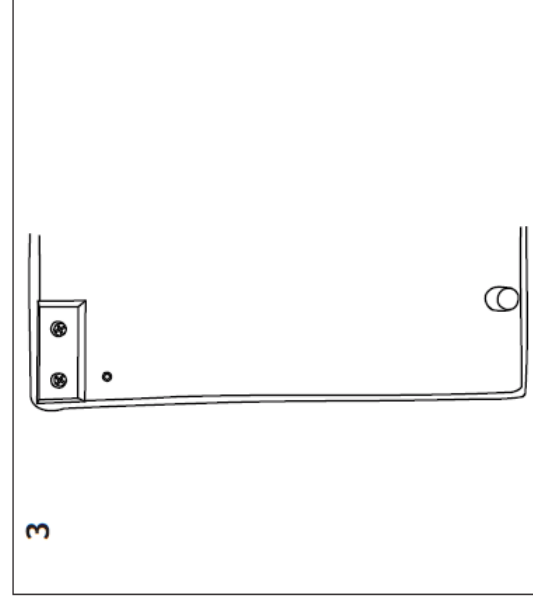
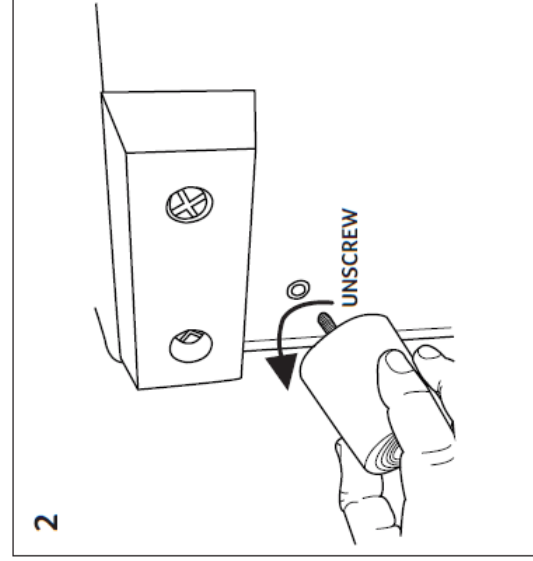
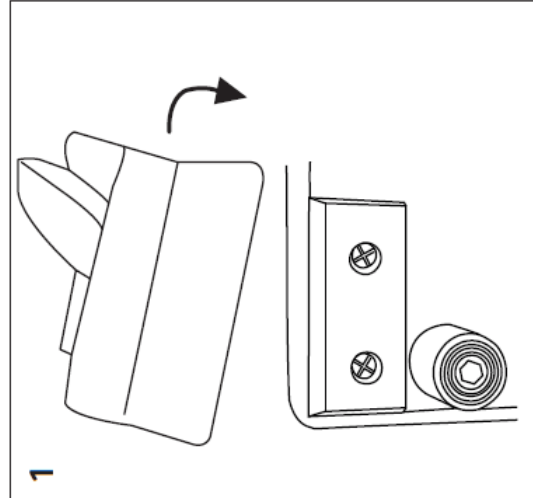



ASSEMBLY INSTRUCTIONS

**DENVER
CORNER SOFA**

MODULAR UNITS - CLIPPING INSTRUCTIONS

FURNITURE IS HEAVY, MOVING OR LIFTING SHOULD NOT BE ATTEMPTED ON YOUR OWN

TO UNCLIP YOUR UNITS PLEASE SKIP TO STAGE 4*

1. THERE ARE 2 SETS OF CLIPS ON YOUR MODULAR UNITS: CLIPS POINTING UP ARE ON LEFT HAND UNITS AND CLIPS POINTING DOWN ARE ON RIGHT HAND UNITS. LOCATE THESE CLIPS ON YOUR FURNITURE. LEFT AND RIGHT UNITS SHOWN BELOW.

2. LINE UP CORRESPONDING UPWARDS AND DOWNWARDS POINTING CLIPS BY PUSHING UNITS CLOSE TOGETHER.

ALWAYS MOVE AND LIFT FURNITURE WITH ANOTHER PERSON, NEVER ON YOUR OWN

3. LIFT RIGHT HAND UNIT AND SLOT DOWNWARDS CLIPS INTO UPWARDS CLIPS ON LEFT HAND UNIT. ALL FEET SHOULD BE LEVEL ON THE FLOOR WHEN FITTED CORRECTLY.

4. TO UNCLIP UNITS GENTLY LIFT THE RIGHT HAND UNIT OUT OF THE LEFT HAND CLIPS AND MOVE AWAY FROM OPPOSING UNIT.

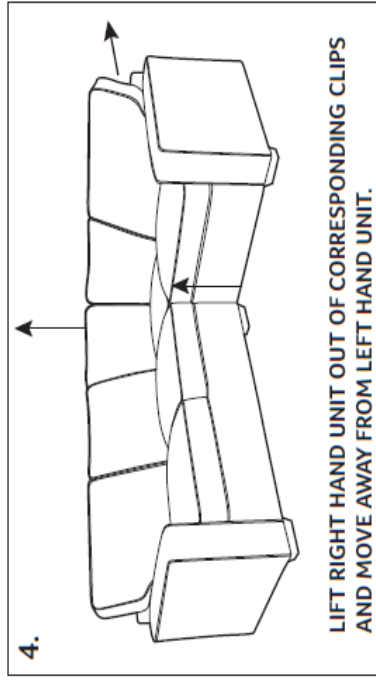
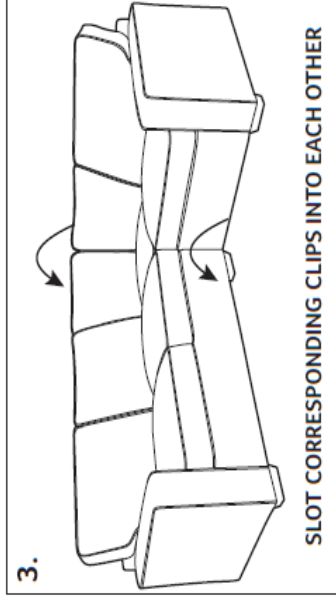
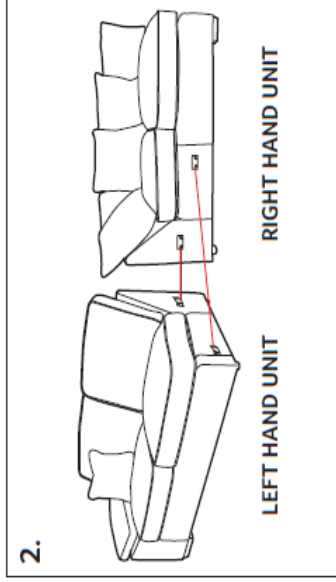
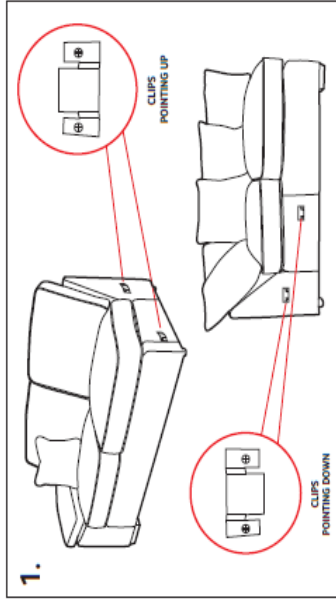

EFFECTIVE FROM PRODUCTION DATE 18/08/2020

Part number: SU-062319